



High Pressure, Pressure Reducing Valve

Model 820

- Flow and leakage reduction
- Cavitation damage protection
- Throttling noise reduction
- Burst protection
- System maintenance savings

The Model 820 High Pressure, Pressure Reducing Valve is a hydraulically operated, piston actuated control valve that reduces higher upstream pressure to lower constant downstream pressure regardless of fluctuating demand or varying upstream pressure.



Features and Benefits

- **Robust structure, piston actuated** – High pressure service
- **Line pressure driven** – Independent operation
- **In-line serviceable** – Easy maintenance
- **Double chamber design** – Moderated valve reaction
- **Flexible design** – Easy addition of features
- **Variety of accessories** – Perfect mission matching
- **“Y” or angle, wide body** – Minimized pressure loss
- **Semi-straight flow** – Non-turbulent flow
- **Stainless Steel raised seat** – Cavitation damage resistant
- **Obstacle free, full bore** – Uncompromising reliability
- **V-Port Throttling Plug** – Low flow stability

Major Additional Features

- Solenoid control – **820-55**
- Check valve – **820-20**
- Solenoid control & check valve – **820-25**
- Proportional – **820-PP**
- Emergency pressure reducing valve – **820-PP-59**
- Downstream over pressure guard – **820-48**
- Electrically selected multi-level setting – **820-45**
- Electronic multi-level setting, Type 4T – **820-4T**
- Electronic pressure reducing valve – **828-03**



Operation

The Model 820 is a pilot controlled valve equipped with an adjustable, 2-Way, pressure reducing pilot. The needle valve [1] continuously allows flow from the valve inlet into the upper control chamber [2]. The pilot [3] senses downstream pressure. Should this pressure rise above pilot setting, the pilot throttles, enabling pressure in the upper control chamber to accumulate, causing the main valve to throttle closed, decreasing downstream pressure to pilot setting.

Should downstream pressure fall below pilot setting, the pilot releases the accumulated pressure, and the main valve modulates open. The needle valve controls the closing speed. The downstream cock valve [4] enables manual closing. Two Models are available, the Standard, Double Chamber 820-PB and the Single Chamber 820-PA*.

The Model 820-PA requires auxiliary closing force. In the size range 6-20"; DN150-500, it is equipped with an auxiliary closing piston [5] connected to valves inlet via a control tube [6]. In the size range 1½-4"; DN40-100, an auxiliary closing spring replaces the piston and the tube.

* Apply Model 820-PA when required pressure-reduction ratio ($P1/P2$) is less than 2.5.

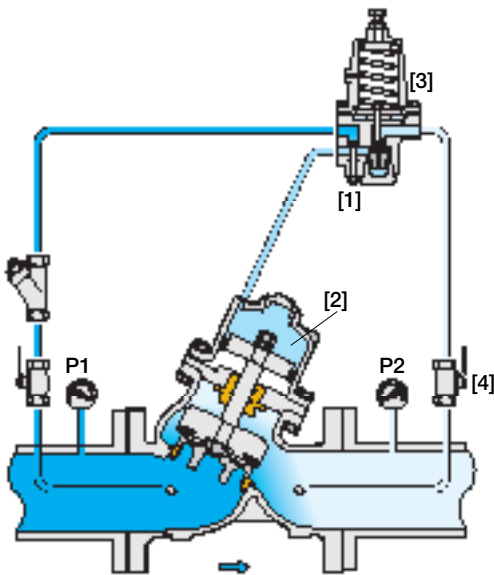

Model 820-PB
Apply when $P1/P2 > 2.5$

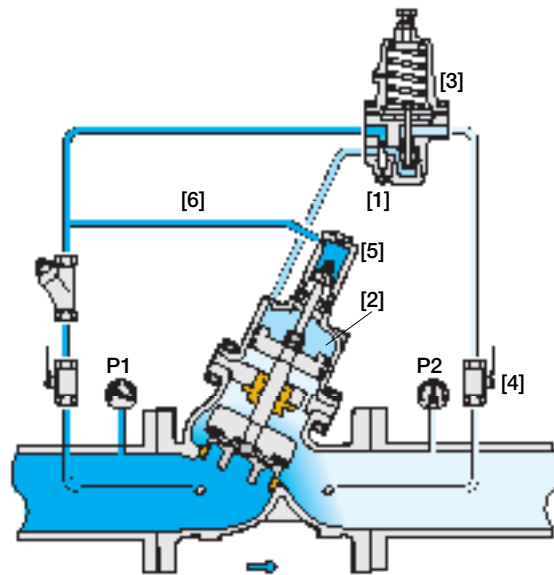

Model 820-PA
Apply when $P1/P2 < 2.5$

Pilot System Specifications

Standard Materials:

Pilot:

Body: Brass or Stainless Steel 316
Elastomers: Synthetic Rubber
Spring: Galvanized Steel or Stainless Steel
Internal parts: Stainless Steel

Tubing & Fittings:

Stainless Steel 316 or Copper & Brass

Accessories:

Stainless Steel 316, Brass and Synthetic Rubber Elastomers

Pilot Adjustment Range:

1 to 16 bar ; 15 to 230 psi - Standard

0.8 to 10 bar ; 11 to 150 psi

2 to 30 bar ; 30 to 430 psi *

2 to 45 bar ; 30 to 650 psi *

* with high pressure kit

Notes:

- Inlet pressure, outlet pressure and flow rate are required for optimal sizing and cavitation analysis
- Recommended continuous flow velocity: 0.3-6.0 m/sec ; 1-20 ft/sec
- Minimum operating pressure: 2.0 bar; 30 psi
- The model 820-PA is equipped with either an auxiliary closing spring (1½-4" / 40-100mm) or an auxiliary closing piston (6-20" / 150-500mm) thus causing an additional head loss of:

Valve Size	Additional Head Loss
1½-4" (40-100mm)	1.0 bar
6" (150mm)	12% of upstream pressure
8" (200mm)	6.5% of upstream pressure
10" (250mm)	10% of upstream pressure
12-14" (300-350mm)	7% of upstream pressure
16-20" (400-500mm)	4% of upstream pressure



Typical Applications

Pressure Reducing System for Municipal Networks

Network design requires establishing various pressure zones due to topography, distances, demands, energy costs, reservoir availability, etc.

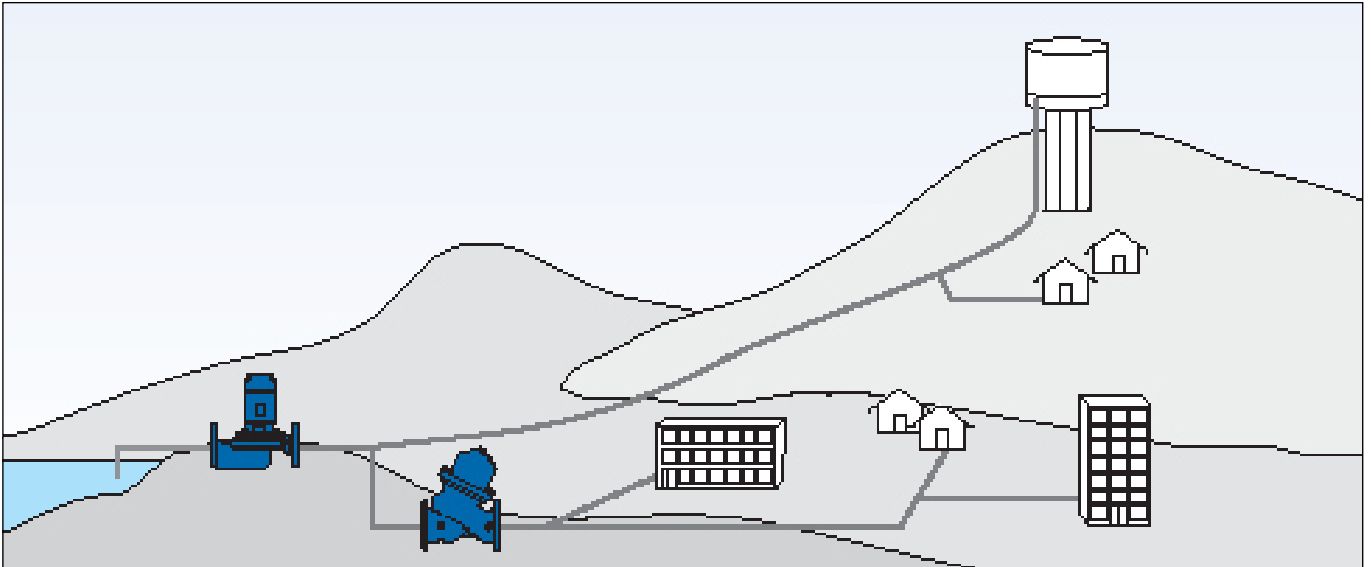

The pump supplies water to the network and to the reservoir. System pressure is too high for the residential neighborhood, requiring a pressure reducing system.

Pressure Reducing System – Typical Installation

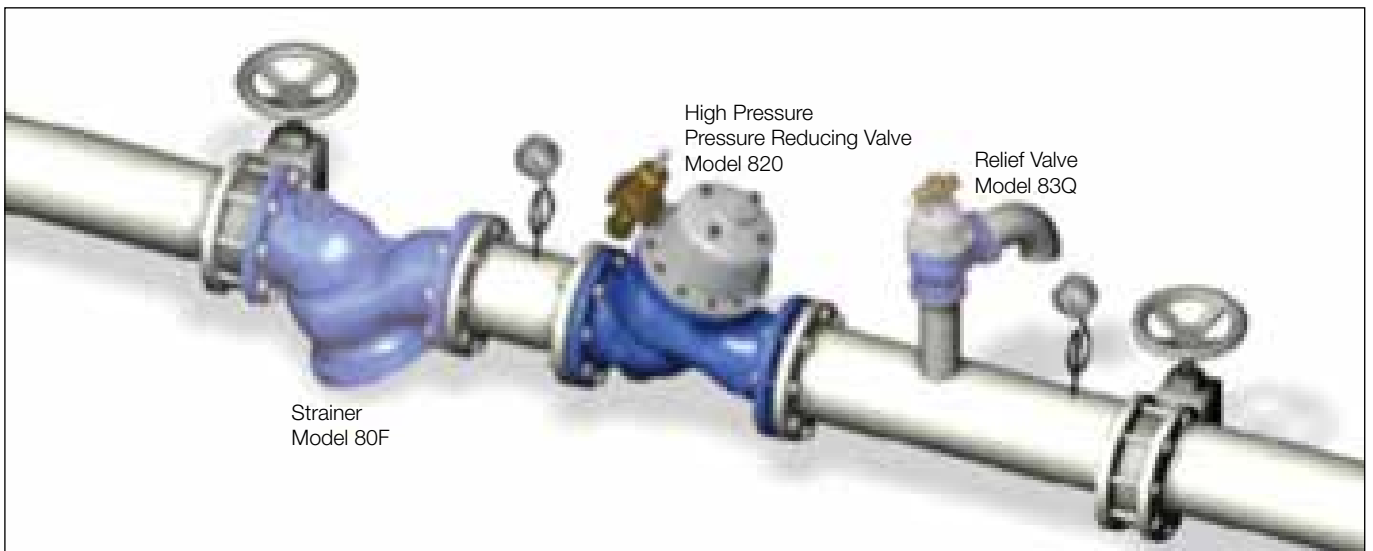

In addition to the **Model 820 High Pressure, Pressure Reducing Valve**, BERMAD recommends that the system also include:

- **High Pressure Strainer Model 80F** preventing debris from damaging valve operation
- **High Pressure, Pressure Relief Valve Model 83Q** providing:
 - Protection against momentary pressure peaks
 - Visual indication of need for maintenance

For more information on BERMAD Pressure Reducing Systems, see BERMAD publication 720, Pressure Reducing Valve.

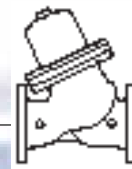

Technical Data

Size Range: DN40-500 ; 1 1/2-20"

End Connections (Pressure Ratings):

Flanged: ISO PN16, PN25, PN40 ; ANSI Class 150, 300, 400

Threaded: BSP or NPT

Others: Available on request

Valve Patterns: "Y" (globe) & angle

Working Temperature: Water up to 80°C ; 180°F

Standard Materials:

Body: Cast Carbon Steel; Ductile Iron; Stainless Steel 316

Cover: Stainless Steel 316; Bronze

Internals: Stainless Steel & Bronze

Seals: Synthetic Rubber

Coating: Fusion Bonded Epoxy, RAL 5005 (Blue) approved for drinking water or Electrostatic Polyester Powder

Differential Pressure Calculation

$$\Delta P = \left(\frac{Q}{(Kv; Cv)} \right)^2$$

ΔP = Differential Pressure for fully open valve (bar; psi)

Q = Flow rate (m³/h; gpm)

Kv = Metric system - valve flow coefficient
(flow in m³/h at 1 bar ΔP with 15°C water)

Cv = US system - Valve flow coefficient
(flow in gpm at 1 psi ΔP with 60°F water)

$$Cv = 1.155 Kv$$

Flow Data & Dimensions Table

Flow Data		DN / Size	40	1.5"	50	2"	65	2.5"	80	3"	100	4"	150	6"	200	8"	250	10"	300	12"	350	14"	400	16"	450	18"	500	20"
800 Kv	800 Angle	Kv / Cv - "Y" Flat	42	49	50	58	55	64	115	133	200	230	460	530	815	940	1,250	1,440	1,850	2,140	1,990	2,300	3,310	3,820	3,430	3,960	3,550	4,100
		Kv / Cv - "Y" V-Port	36	41	43	49	47	54	98	113	170	200	391	450	693	800	1,063	1,230	1,573	1,820	1,692	1,950	2,814	3,250	2,916	3,370	3,018	3,490
800 Kv	800 Angle	Kv / Cv - "A" Flat	46	53	55	64	61	70	127	146	220	250	506	580	897	1,040	1,375	1,590	2,035	2,350	2,189	2,530	3,641	4,210	3,773	4,360	-	-
		Kv / Cv - "A" V-Port	39	45	47	54	51	59	108	124	187	220	430	500	762	880	1,169	1,350	1,730	2,000	1,861	2,150	3,095	3,580	3,207	3,710	-	-
800 "Y" Flanged	PN10; 16 Class 150	L (mm / inch)	205	8.1	210	8.3	222	8.7	250	9.8	320	12.6	415	16.3	500	19.7	605	23.8	725	28.5	733	28.9	990	39.0	1,000	39.4	1,100	43.3
		W (mm / inch)	156	6.1	166	6.5	190	7.5	200	7.9	229	9.0	286	11.3	344	13.5	408	16.1	484	19.1	536	21.1	600	23.6	638	25.1	716	28.2
		h (mm / inch)	78	3.1	83	3.3	95	3.7	100	3.9	115	4.5	143	5.6	172	6.8	204	8.0	242	9.5	268	10.6	300	11.8	319	12.6	358	14.1
		H (mm / inch)	260	10.2	265	10.4	278	10.9	327	12.9	409	16.1	526	20.7	650	25.6	763	30.0	942	37.1	969	38.1	1,154	45.4	1,173	46.2	1,211	47.7
		P (mm / inch)	-	-	-	-	-	-	-	-	-	-	-	135	5.3	135	5.3	142	5.6	154	6.1	154	6.1	191	7.5	191	7.5	191
	Weight (Kg/lb)	10.7	24	13	29	16	35	28	62	48	106	94	207	162	356	272	598	455	1,001	482	1,060	1,000	2,200	1,074	2,363	1,096	2,411	
	PN25; 40 Class 300	L (mm / inch)	205	8.1	210	8.3	222	8.7	264	10.4	335	13.2	433	17.0	524	20.6	637	25.1	762	30.0	767	30.2	1,024	40.3	1,030	40.6	1,136	44.7
		W (mm / inch)	156	6.1	166	6.5	190	7.5	210	8.3	254	10.0	318	12.5	382	15.0	446	17.6	522	20.6	590	23.2	650	25.6	714	28.1	778	30.6
		h (mm / inch)	78	3.1	83	3.3	95	3.7	105	4.1	127	5.0	159	6.3	191	7.5	223	8.8	261	10.3	295	11.6	325	12.8	357	14.1	389	15.3
		H (mm / inch)	260	10.2	265	10.4	278	10.9	332	13.1	422	16.6	542	21.3	666	26.2	783	30.8	961	37.8	996	39.2	1,179	46.4	1,208	47.6	1,241	48.9
P (mm / inch)		-	-	-	-	-	-	-	-	-	-	-	141	5.6	141	5.6	142	5.6	154	6.1	154	6.1	191	7.5	191	7.5	191	7.5
Weight (Kg/lb)	11.8	26	15	33	18.4	40	32	70	56	123	106	233	190	418	307	675	505	1,111	549	1,208	1,070	2,354	1,095	2,409	1,129	2,484		
800 Angle, Flanged	PN10; 16 Class 150	L (mm / inch)	124	4.9	124	4.9	149	5.9	152	6.0	190	7.5	225	8.9	265	10.4	320	12.6	396	15.6	400	15.7	450	17.7	450	17.7	-	-
		W (mm / inch)	156	6.1	166	6.5	190	7.5	200	7.9	229	9.0	285	11.2	344	13.5	408	16.1	496	19.5	528	20.8	598	23.5	640	25.2	-	-
		R (mm / inch)	78	3.1	83	3.3	95	3.7	100	3.9	115	4.5	143	5.6	172	6.8	204	8.0	248	9.8	264	10.4	299	11.8	320	12.6	-	-
		h (mm / inch)	85	3.3	85	3.3	109	4.3	102	4.0	127	5.0	152	6.0	203	8.0	219	8.6	273	10.7	279	11.0	369	14.5	370	14.6	-	-
		H (mm / inch)	252	9.9	252	9.9	271	10.7	308	12.1	390	15.4	476	18.7	619	24.4	717	28.2	911	35.9	915	36.0	1,144	45.0	1,144	45.0	-	-
	P (mm / inch)	-	-	-	-	-	-	-	-	-	-	-	141	5.6	141	5.6	156	6.1	156	6.1	156	6.1	195	7.7	195	7.7	-	-
	Weight (Kg/lb)	10.7	24.0	13	29.0	16	35.0	26	57.0	46	101	90	198	153	337	259	570	433	953	459	1,010	950	2,090	1,020	2,244	-	-	
	PN25; 40 Class 300	L (mm / inch)	124	4.9	124	4.9	149	5.9	159	6.3	200	7.9	234	9.2	277	10.9	336	13.2	415	16.3	419	16.5	467	18.4	467	18.4	-	-
		W (mm / inch)	150	5.9	155	6.1	190	7.5	200	7.9	254	10.0	318	12.5	381	15.0	446	17.6	522	20.6	586	23.1	650	25.6	716	28.2	-	-
		R (mm / inch)	78	3.1	85	3.3	95	3.7	105	4.1	127	5.0	159	6.3	191	7.5	223	8.8	261	10.3	293	11.5	325	12.8	358	14.1	-	-
h (mm / inch)		85	3.3	85	3.3	109	4.3	109	4.3	135	5.3	165	6.5	216	8.5	236	9.3	294	11.6	299	11.8	386	15.2	386	15.2	-	-	
H (mm / inch)		252	9.9	264	10.4	271	10.7	315	12.4	398	15.7	491	19.3	632	24.9	733	28.9	930	36.6	935	36.8	1,160	45.7	1,160	45.7	-	-	
P (mm / inch)	-	-	-	-	-	-	-	-	-	-	-	141	5.6	141	5.6	156	6.1	156	6.1	156	6.1	195	7.7	195	7.7	-	-	
Weight (Kg/lb)	11.8	26	15	33	18.4	40	30	66	54	119	101	222	179	394	292	642	481	1,058	523	1,151	1,017	2,237	1,051	2,312	-	-		

"Y" Pattern

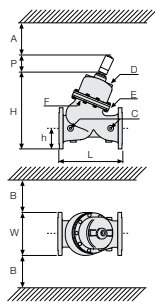

Angle Pattern

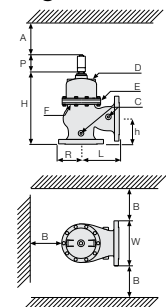

Specify when ordering:

- Size
 - Main model
 - Additional features
 - Pattern
 - Body material
 - End connection
 - Coating
 - Voltage & main valve position
 - Tubing & Fittings materials
 - Operational data (according to model)
 - Pressure data
 - Flow data
 - Reservoir level data
 - Settings
- * Use Bernad's Waterworks Ordering Guide



Trädgårdsteknik AB
Helsingborgsvägen 578
262 96 ÄNGELHOLM
Telefon: 0431-222 90
Telefax: 0431-222 70
info@tradgardsteknik.se
www.tradgardsteknik.se