

BERMAD Fire Protection

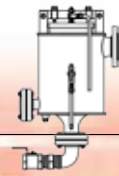

Model: TOO

Separation Valves

Automatic Separation Valve

Model: TOO

The BERMAD model TOO is a specific gravity sensitive valve, for the automatic draining of a heavier fluid from a lighter fluid.

Commonly used for the draining of water accumulated in the bottom of petroleum product storage tanks where the stored medium has a lower specific gravity than that of the accumulated water. The TOO valve should be opened to initiate dewatering. When all the accumulated water has drained from the storage tank the presence of product will be sensed by the TOO valve and it will automatically and immediately shut off drip tight. When fitted with the optional factory fitted limit switch, a signal can be sent to a remote valve position monitoring system, signaling that the valve is closed.

It is well suited for use with storage tanks containing Gasoline, Gas Oil, Jet Fuel, Kerosene, Diesel Oil, Crude Oil and all Petroleum products including Light Crude Oil. The TOO uses a simple and reliable principle with a straightforward and compact construction, designed to require minimal maintenance, and to last the lifetime of the tank.

Using the TOO can save product loss, work hours, and increase available tank storage space. It is environmentally cleaner, safer, more reliable and efficient compared to manual or other methods

Each valve is assembled and tested in the BERMAD ISO 9000 and 9001 certified manufacturing plant.

Introduced to the industry in 1997 the TOO is a time proven product in use in over 20 countries worldwide and backed by the Global Service Network of BERMAD.

Features and Benefits

Safety

- Reduced technicians exposure to harmful product fumes
- Eliminates product spillage during dewatering
- Integral strainer for reliable sealing

High Performance

- Immediate closing response when product detected
- High accuracy / repeatability
- High drain flow efficiency
- Built in Anti Vortex Device, for efficient controlled flow

Cost Effective

- Very low maintenance
- No external power supply needed
- Increases available product storage space
- Saves in work hours
- Greatly reduces the plants total water treatment volume

Factory Fitted Options

- **Limit Switch:** Atex or Nema Div. 1/Zone 1 hazardous areas approved
- **Manual Pump:** for above tank bottom installations
- **Crude Oil Compatibility**
- **Outlet Valve Handle Extension:** for pit installations



Patented

Cover

Vent/Sampling Valve

Inlet

Float Guide/Strainer

Equalizing Valve

Float

Seal

Limit Switch

Outlet Valve



BERMAD Fire Protection

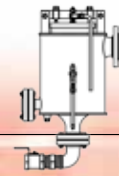

Separation Valves

Model: TOO

Principle of Operation

Normal Operation (before dewatering)

Water that accumulates in the bottom of the storage tank reaches the TOO valve.

At this stage the float (2) is pressed, by the water pressure above it, against the seal at bottom of the valve sealing drip tight.

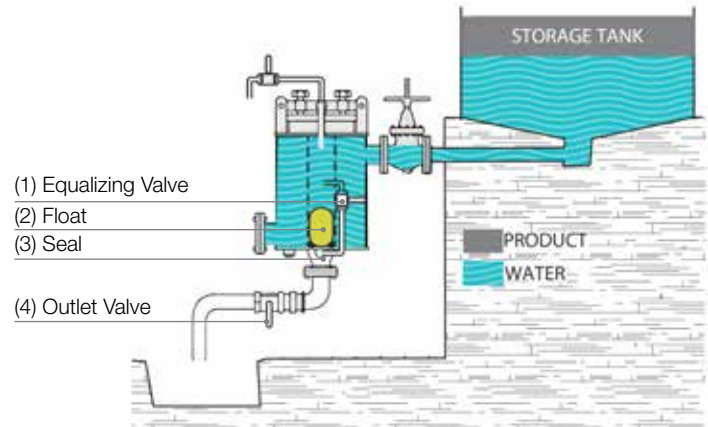

Dewatering

Dewatering is initiated by momentarily opening the pressure equalizing valve (1) if water is present, the float will rise thus opening the outlet seal (3).

The outlet valve (4) should now be opened to allow free flow of the accumulated water to the drainage system.

During drainage the Integral Strainer will help to keep the TOO seal clear of the debris often experienced in the bottom of storage tanks, ensuring a reliable seal at the end of the dewatering session.

The built in Anti Vortex Device will control the flow, preventing the formation of a Vortex within the storage tank mixing the natural phase between the product and the accumulated water.

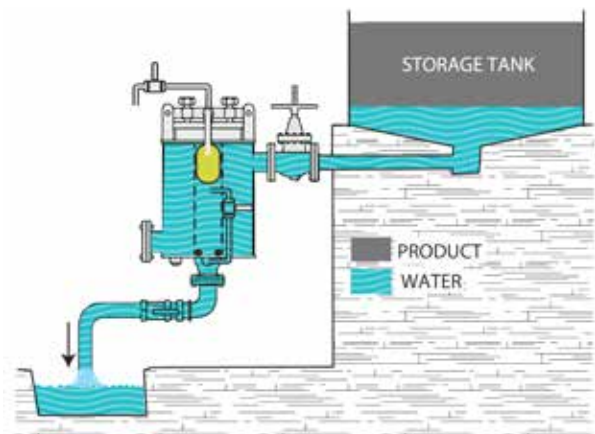

Normal Operation

When the water has completely drained and product enters the TOO valve, the float (2) quickly descends in the lighter medium and seals the valve.

After closing, the float remains hydraulically pressed against the seat, sealing the outlet.

The TOO should be reset by closing the outlet valve (4) until the next dewatering session.

Remaining product in the TOO will "float" back to the tank and will be naturally replaced with forthcoming accumulated water.

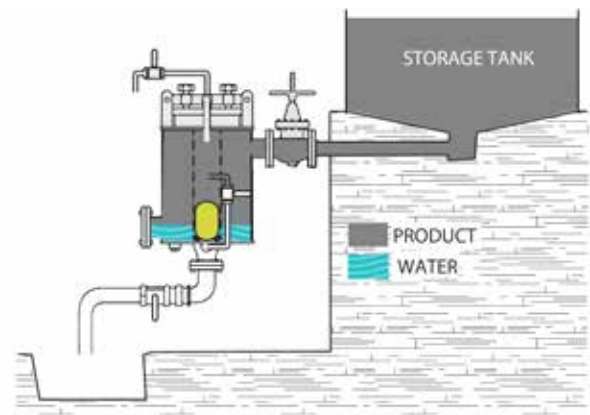

System P&ID

1. Separating valve body
2. Strainer/float guide
3. Balanced float
4. Vortex inhibitor
5. Equalizing valve (spring return N.C)
6. Outlet ball valve
7. Venting/sampling valve
8. Storage tank drain valve
9. Storage tank /gravity separation
10. Sump plug

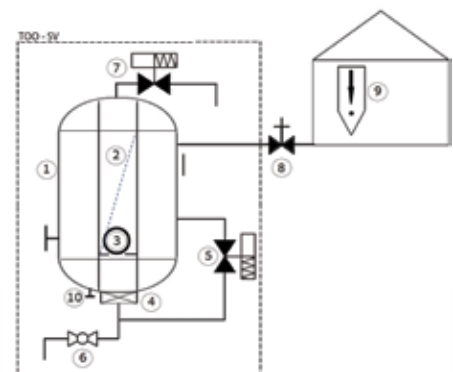

BERMAD Fire Protection

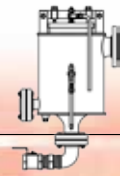

Model: TOO

Separation Valves

Typical Installation and Maintenance

It is recommended, where possible, to install the BERMAD TOO dewatering separation valve at or below the lowest point of the storage tank (see Fig 1). This ensures that any residual product remaining in the BERMAD TOO valve after a dewatering session, will "float" back up into the storage tank as accumulated heavier water enters the TOO. In installations where the TOO valve can only be installed at a point higher than the lowest point of the storage tank (see Fig 2) a factory fitted manual pump is available to return in a clean and efficient manner any residual product left inside the TOO valve after dewatering, back to the tank or into a collecting vessel.

To enable the vortex inhibitor to perform correctly and prevent the formation of a vortex spout within the storage tank, there should be an air gap between the outlet and the drain (see Fig 1). This air gap serves as a suction breaker, and keeps the outlet flow stable. The flow or outlet capacity of the TOO is also determined by the inlet head before the TOO valve - see the Flow Chart on page 4.

The compact and lightweight construction of the TOO facilitates a trouble free attachment of the device, usually directly onto existing outlet pipes or flanges. Opening the BERMAD TOO valve for periodical maintenance and access to all internal parts is accomplished by simply releasing the 2 cover bolts and removing the holding bolt.

The BERMAD TOO is designed for easy upkeep. It has a lightweight and compact, yet robust construction with only one moving part and with all internal parts being manufactured in appropriate grade stainless steel.

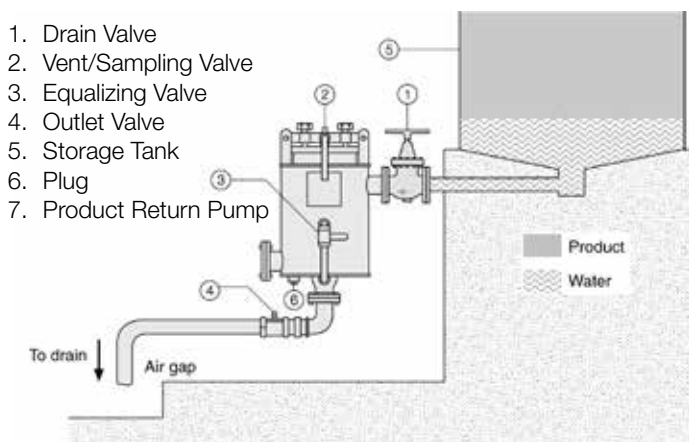

Fig 1: Installation at the lowest point of the tank

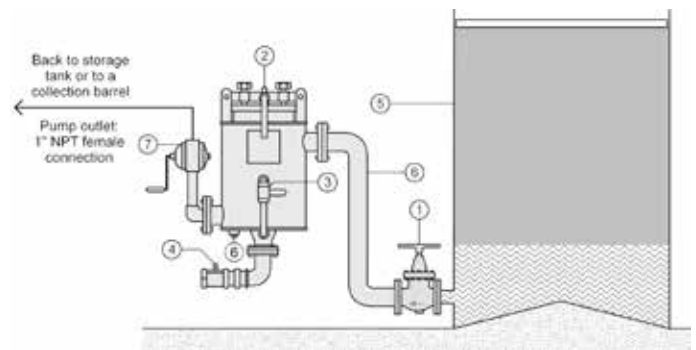

Fig 2: Installation higher than the lowest point of the tank

Engineer Specifications

The Automatic Draining Valve shall be made of a fusion bonded epoxy coated carbon steel body and will include an integral stainless steel Strainer with perforations diameter of 10mm/0.39 in. The valve shall be equipped with a built-in device for the prevention of a vortex development within the storage tank during draining.

Installation shall not require any incursion or penetration of the storage tank wall.

The Automatic Drain Valve shall include a factory fitted limit switch ATEX ZONE 1 or NEC Class I Div. 1, properly certified for hazardous sites classifications.

All external piping, fittings, bolting and all metallic internal parts shall be made of stainless steel.

No additional parts shall be required for resetting.

Removing the valve cover for inspection or maintenance shall be in line and shall not require removal of the valve from the pipeline.

The Automatic Drain Valve shall be assembled and hydraulically tested by a factory certified to ISO9000 and 9001.

BERMAD Fire Protection

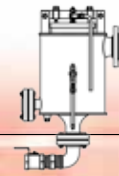

Separation Valves

Model: **TOO**

Technical Specifications

Part	Material
Valve Body and Cover	Carbon Steel to AISI 1030
Internal Parts	Stainless Steel
Elastomeric	H-NBR
Ball Valves	Stainless Steel AISI 316
Bolts	Stainless Steel AISI 316
Plugs	Stainless Steel AISI 303
Coating	Fusion Bonded Epoxy : RAL 5017 approx, GSK Certified , AS/NZS 4158:2003 compliant
Inlet Connection*	4" ANSI #150 RF B16.5
Drain Connection	Threaded NPT/BSPT
Limit Switch	Stainless Steel – ATEX or NEMA Zone 1 Div 1 for Hazardous Locations
Working Pressure	2.5 bar / 36 psi
Approx Weight	64 kg / 141 lb

*Other connections available – contact BERMAD

Dimensions

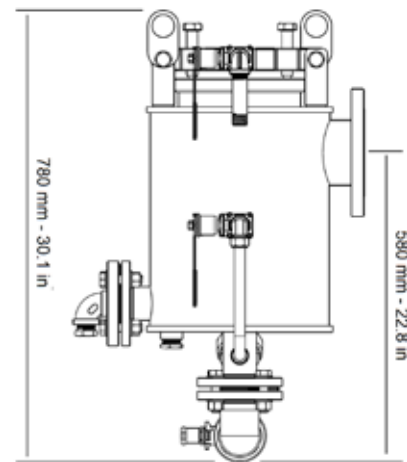
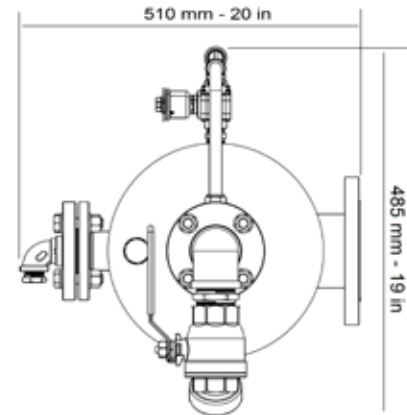

Flow Chart

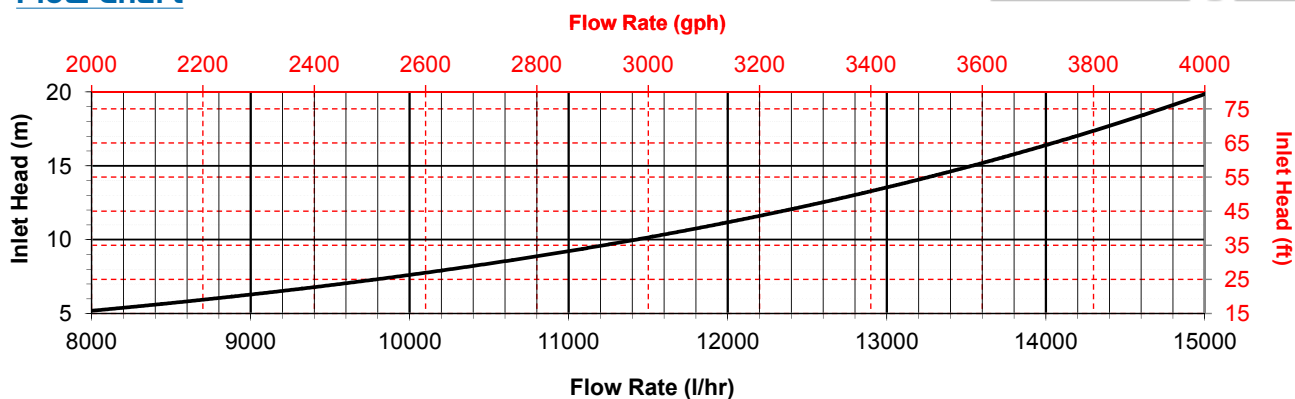

* For crude oil compatible models consult BERMAD

Ordering Code Designations

Type	Size	Connection	Options
TOO	4"	A5	PCS9A
		ANSI#150 - A5	Limit Switch (Atex) - S9A
		ISO 16 - 16	Limit Switch (NEMA) - S9N
			Outlet Valve Handle Extension - M
			Crude Oil Compatible - C
			Manual Return Pump - P



Trädgårdsteknik AB
Helsingborgsvägen 578
262 96 ÄNGELHOLM
Telefon: 0431-222 90
Telefax: 0431-222 70
info@tradgardsteknik.se
www.tradgardsteknik.se
