

Economic

- Standaard / Standard
- ESR5

Versie 1
Version 1
22-03-2011

			Datum		Economic		Voorblad Title sheet	Eco01	=		
			Eng.	FvK/RT						+	
			Gez.	22. Mrt. 2011							B1. 1
Wijziging	Datum	Naam	Norm							8 B1.	

Inhoudsopgave

Index

Pagina 1	Voorblad	Title sheet	Page 1
Pagina 2	Inhoudsopgave - Betekenis afkortingen	Index - Abbreviations wirecolors	Page 2
Pagina 3	Hoofdstroom	Primary current	Page 3
Pagina 4	Hoofdstroom	Primary current	Page 4
Pagina 5	Stuurstroom	Control voltage	Page 5
Pagina 6	Indeling schakelkast	Layout panel	Page 6
Pagina 7	Klemmen	Terminals	Page 7
Pagina 8	Frontindeling	Front view	Page 8

Betekenissen gebruikte afkortingen / Meaning shortenings			
Draadkleuren / wirecolors			
bruin / brown 6mmq	bn6	bruin / brown 4mmq	bn4
blauw / blue 6mmq	bw6	blauw / blue 4mmq	bw4
zwart / black 6mmq	zt6	zwart 4mmq	zt4
groen/geel 6mmq	gng16	groen/geel 4mmq	gng14
green/yellow 6mmq		green/yellow 4mmq	
bruin / brown 2,5mmq	bn2	bruin / brown 1,5mmq	bn1
blauw / blue 2,5mmq	bw2	blauw / blue 1,5mmq	bw1
zwart / black 2,5mmq	zt2	zwart / black 1,5mmq	zt1
groen/geel 2,5mmq	gng12	groen/geel 1,5mmq	gng11
green/yellow 2,5mmq		green/yellow 1,5mmq	
bruin / brown 0,75mmq	bn	oranje 0,75mmq	oe
zwart / black 0,75mmq	zt	orange 0,75mmq	
groen/geel 0,75mmq	gng1	grijs / grey 0,75mmq	gs
green/yellow 0,75mmq		geel / yellow 0,75mmq	gl
rood / red 0,75mmq	rd	paars / purple 0,75mmq	ps
donkerblauw 0,75mmq	dbw	groen / green 0,75mmq	gn
dark blue 0,75mmq		wit / white 0,75mmq	wt

Klemmenstroken en kabels / Terminals and cables	
W1	Kabel met steker naar motor band / Cable with plug to motor belt
W2	Kabel motor boor / Cable motor drill
W3	Kabel motor pottenbaan / Cable motor pottrack
W4	Kabel motor elevator / Cable motor elevator
W5	Kabel motor pottenvoorraadband / Cable motor pottstock

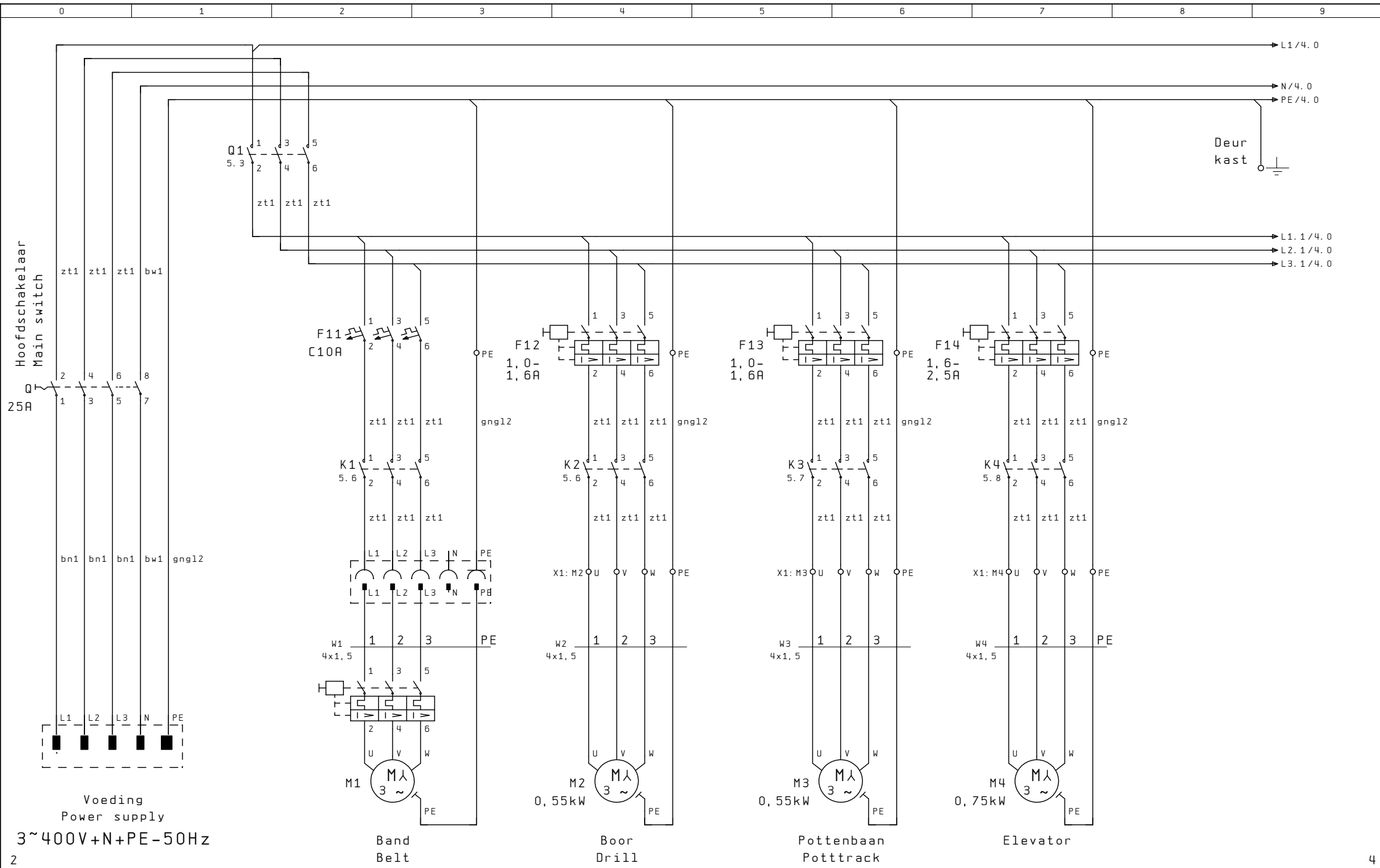

				Datum				
				Eng.	FvK/RT			
				Gez.	22. Mrt. 2011			
					Economic			
				Hoofdstroom Primary current				
				Eco01				
				=				
				+				
				B1. 3				
				8 B1				

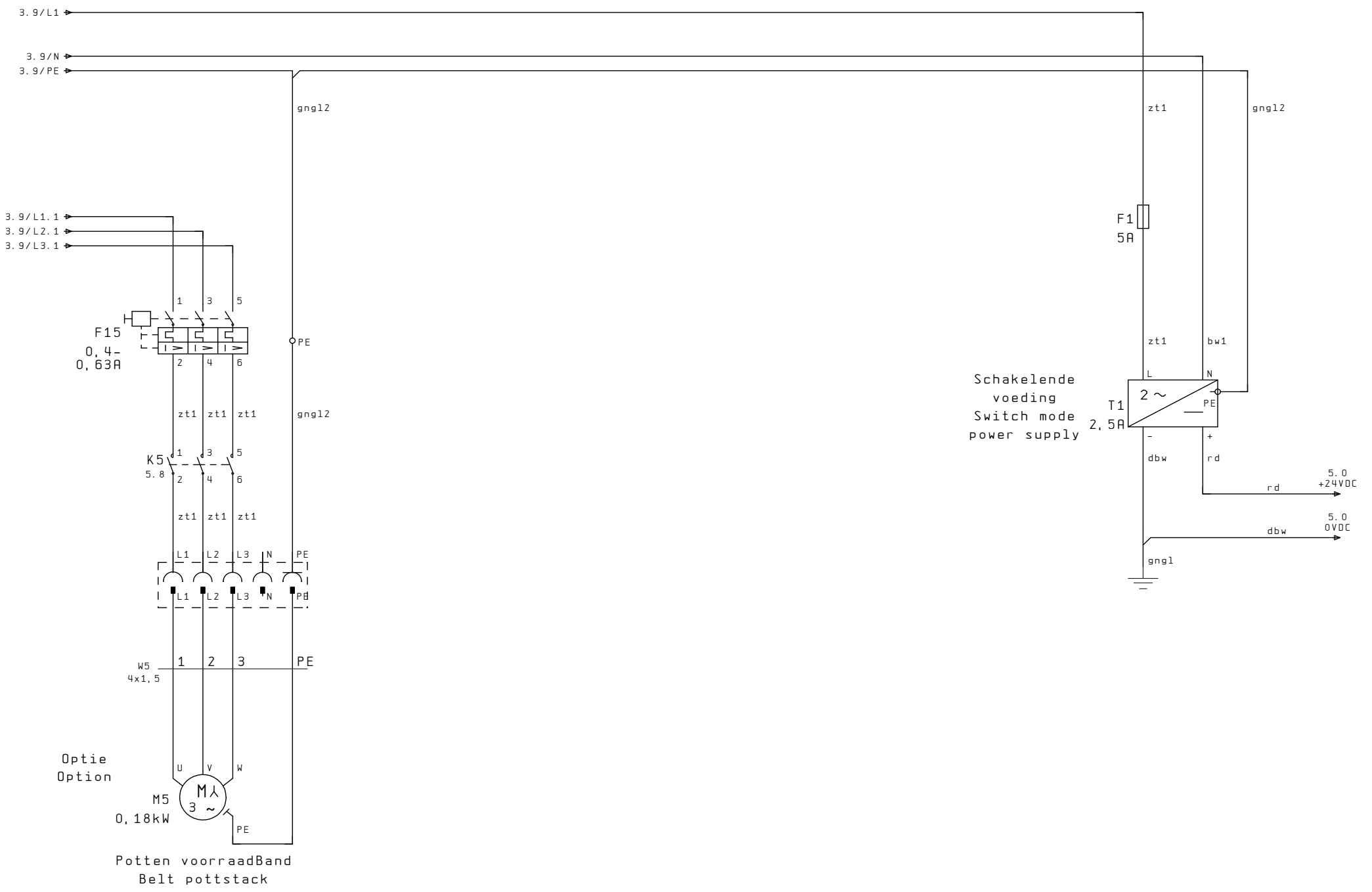

			Datum		Economic		Hoofdstroom Primary current	Eco01	=			
		Eng.	FvK/RT									
		Gez.	22. Mrt. 2011									B1. 4
Wijziging	Datum	Naam	Norm							8 B1.		

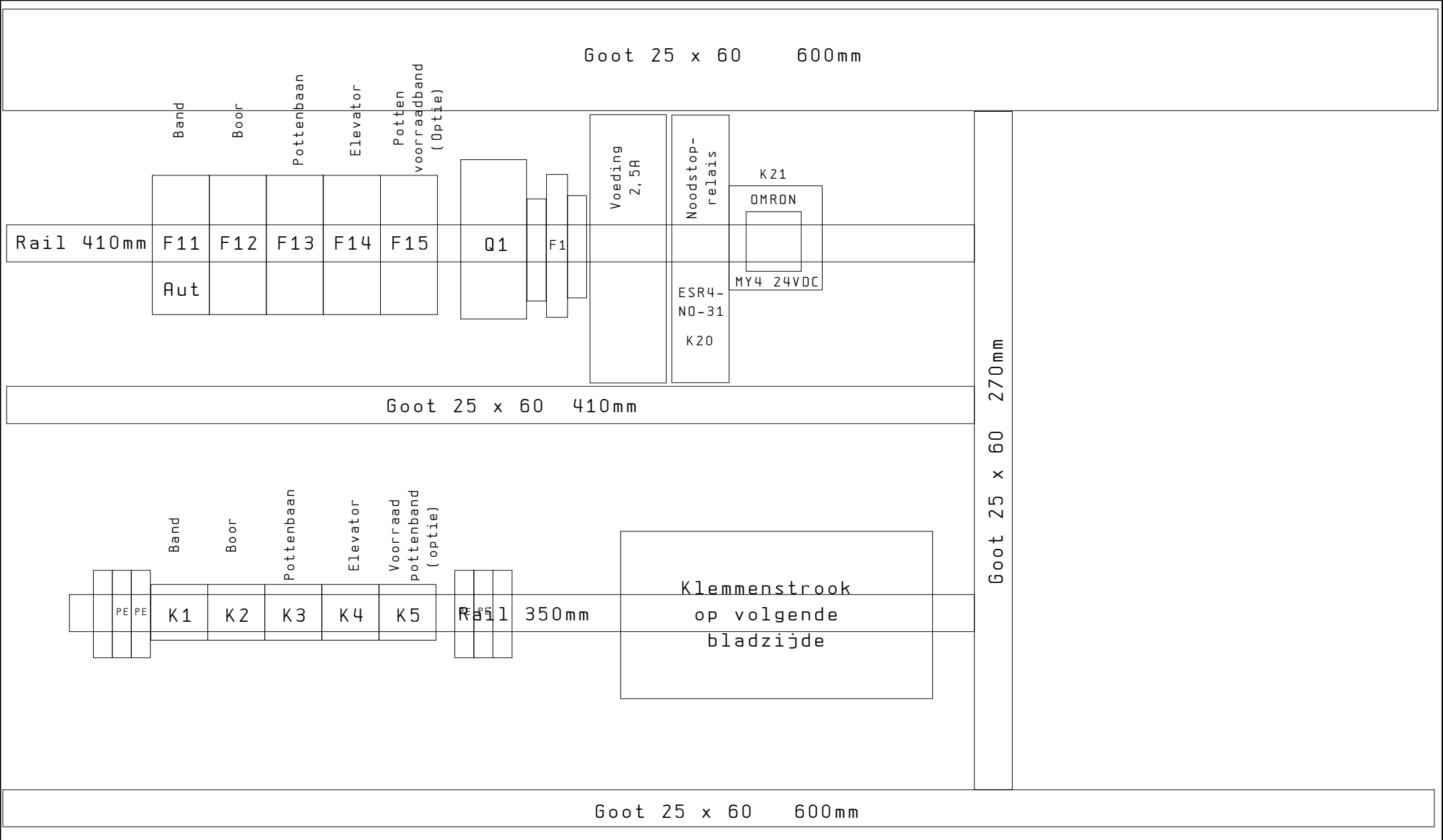

WCD 1 Voeding	WCD 2 Geschakeld	WCD 3 (Optie)	Voorraad pottenband
------------------	---------------------	------------------	------------------------

5

7

	Datum		
	Eng.	FvK/RT	
	Gez.	22. Mrt. 2011	
Wijziging	Datum	Naam	Norm

Economic



Indeling schakelkast
Layout panel

Eco01

=	
+	
	B1. 6
	8 B1.

X2

Rail

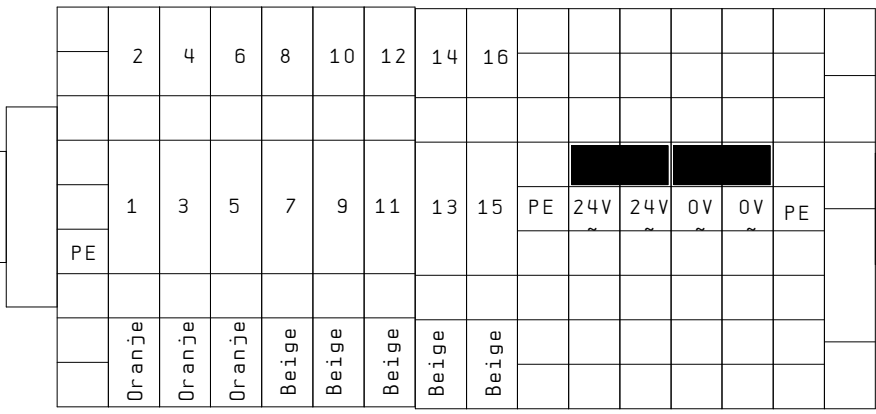

Rail

Legenda

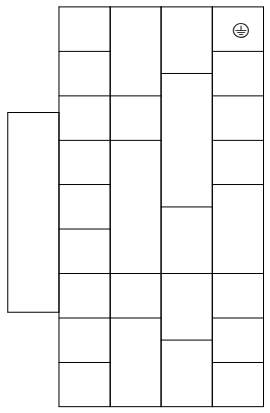

Eindklem
Twin klem
2-etage klem
PLC klem
Motor klem

			Datum	
			Eng.	FvK/RT
			Gez.	22. Mrt. 2011
Wijziging	Datum	Naam	Norm	

Economic



Klemmen
Terminals

Eco01

=	
+	
	B1. 7
	8 B1.

Hoofdschakelaar

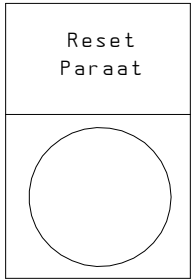

Blauwe
druknop

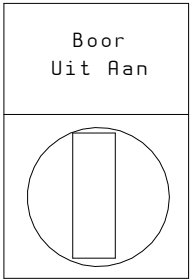

2-standen
schakelaar



2-standen
schakelaar

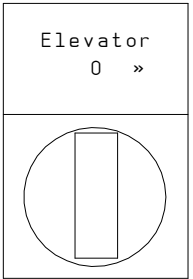

2-standen
schakelaar

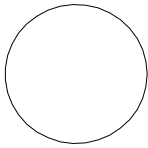

reserve

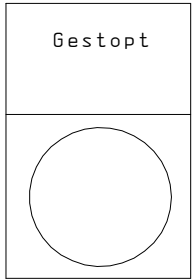

Rode lens

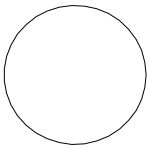

reserve

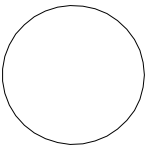

reserve

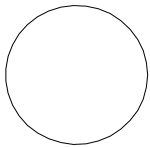

reserve

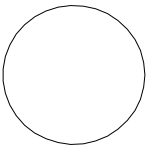

reserve

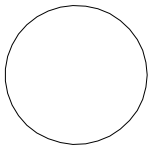

reserve

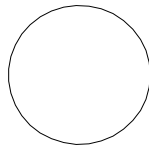

reserve

			Datum	
			Eng.	FvK/RT
			Gez.	22. Mrt. 2011
Wijziging	Datum	Naam	Norm	

Economic



Frontindeling
Front view

Eco01

=	
+	
	B1. 8
	8 B1.

Trädgårdsteknik AB
Helsingborgsvägen Varalöv
262 96 ÄNGELHOLM
Tel: 0431-22290
Fax: 0431-22270
Mail: info@[tradgardsteknik.se](mailto:info@tradgardsteknik.se)
Webb: www.tradgardsteknik.se